



*User Manual*

*HM78X DIGITAL MOBILE RADIO*



## Preface

Welcome to the world of Hytera and thank you for purchasing this product. This manual includes a description of the functions and step-by-step procedures for use.

To avoid bodily injury or property loss caused by incorrect operation, please carefully read the *Safety Information Booklet* before use.

This manual is applicable to the following product:

HM78X Digital Mobile Radio (X may represent 2, 5, 6, or 8)

## Copyright Information

Hytera is the trademark or registered trademark of Hytera Communications Corporation Limited (the Company) in the People's Republic of China (PRC) and/or other countries or areas. The Company retains the ownership of its trademarks and product names. All other trademarks and/or product names that may be used in this manual are properties of their respective owners.

The product described in this manual may include the Company's computer programs stored in memory or other media. Laws in PRC and/or other countries or areas protect the exclusive rights of the Company with respect to its computer programs. The purchase of this product shall not be deemed to grant, either directly or by implication, any rights to the purchaser regarding the Company's computer programs. The Company's computer programs may not be copied, modified, distributed, decompiled, or reverse-engineered in any manner without the prior written consent of the Company.

## Disclaimer

The Company endeavors to achieve the accuracy and completeness of this manual, but no warranty of accuracy or reliability is given. All the specifications and designs are subject to change without notice due to continuous technological development. No part of this manual may be copied, modified, translated, or distributed in any manner without the prior written consent of the Company.

We do not guarantee, for any particular purpose, the accuracy, validity, timeliness, legitimacy or completeness of the third-party products and contents involved in this manual.

If you have any suggestions or would like to receive more information, please visit our website at: <http://www.hytera.com>.

## RF Radiation Information

This product must be restricted to operations in an Occupational/Controlled RF exposure Environments. Users must be fully aware of the hazards of the exposure and able to exercise control over their RF exposure to qualify for the higher exposure limits.

## RF Radiation Profile

Radio Frequency (RF) is a frequency of electromagnetic radiation in the range at which radio signals are transmitted. RF technology is widely used in communication, medicine, food processing and other fields. It may generate radiation during use.

## RF Radiation Safety

In order to ensure user health, experts from relevant industries including science, engineering, medicine and health work with international organizations to develop standards for safe exposure to RF radiation. These standards consist of:

- United States Federal Communications Commission, Code of Federal Regulations; 47 CFR § 1.1307, 1.1310 and

2.1091

- American National Standards Institute (ANSI)/Institute of Electrical and Electronic Engineers (IEEE) C95. 1:2005; Canada RSS102 Issue 5 March 2015
- Institute of Electrical and Electronic Engineers (IEEE) C95.1:2005 Edition

## FCC Statement

This equipment has been tested and found to comply with the limits for a Class B digital device, pursuant to part 15 of FCC Rules. These limits are designed to provide reasonable protection against harmful interference in a residential installation. This equipment generates and can radiate radio frequency energy. If not installed and used in accordance with the instructions, it may cause harmful interference to radio communications. However, there is no guarantee that interference will not occur in a particular installation. Verification of harmful interference by this equipment to radio or television reception can be determined by turning it off and then on.

The user is encouraged to try to correct the interference by one or more of the following measures:

- Reorient or relocate the receiving antenna. Increase the separation between the equipment and receiver.
- Connect the equipment into an outlet on a different circuit to that of the receiver's outlet.
- Consult the dealer or an experienced radio/TV technician for help.

Operation is subject to the following two conditions:

- This device may not cause harmful interference.
- This device must accept any interference received, including interference that may cause undesired operation.

Note: Changes or modifications to this unit not expressly approved by the party responsible for compliance could void the user's authority to operate the equipment.

## FCC Regulations

Federal Communication Commission (FCC) requires that all radio communication products should meet the requirements set forth in the above standards before they can be marketed in the U.S, and the manufacturer shall post a RF label on the product to inform users of operational instructions, so as to enhance their occupational health against exposure to RF energy.

## Operational Instructions and Training Guidelines

To ensure optimal performance and compliance with the occupational/controlled environment RF energy exposure limits in the above standards and guidelines, users should always adhere to the followings:

Gain of antenna must not exceed 5 dBi (UHF) or 3.5 dBi (VHF).

Antenna Installation: install the antenna at least 100 cm away from your body, in accordance with the requirements of the antenna manufacturer/supplier.

## **EU Regulatory Conformance**

As certified by the qualified laboratory, the product is in compliance with the essential requirements and other relevant provisions of 2014/53/EU.

Please note that the above information is applicable to EU countries only.

# Contents

<b>Documentation Conventions</b> .....	<b>3</b>
<b>1. Packing List</b> .....	<b>4</b>
<b>2. Product Overview</b> .....	<b>5</b>
2.1 Product Layout.....	5
2.1.1 Front Panel .....	5
2.1.2 Rear Panel.....	6
2.1.3 Palm Microphone.....	7
2.2 Programmable Keys .....	7
<b>3. Installation</b> .....	<b>8</b>
3.1 Instructions .....	8
3.2 Tools .....	8
3.3 Parts .....	9
3.4 Procedure .....	10
3.4.1 Installing the TF Card .....	10
3.4.2 Installing the Radio .....	11
<b>4. Basic Operations</b> .....	<b>12</b>
4.1 Turning On or Off the Radio.....	12
4.2 Adjusting the Volume .....	12
4.3 Switching the Operation Mode.....	12
4.3.1 Conventional Mode.....	12
4.3.2 Trunking Mode.....	13
<b>5. Status Indications</b> .....	<b>15</b>
5.1 LCD Icons .....	15
5.2 LED Indicators .....	16
<b>6. Call Services</b> .....	<b>18</b>
6.1 Group Call.....	18
6.1.1 Initiating a Group Call .....	18
6.1.2 Receiving a Group Call.....	20
6.1.3 Ending a Group Call .....	20
6.2 Private Call .....	20
6.2.1 Initiating a Private Call.....	20
6.2.2 Receiving a Private Call.....	22
6.2.3 Ending a Private Call .....	22
6.3 All Call.....	22
6.3.1 Initiating an All Call .....	23
6.3.2 Receiving an All Call .....	24
6.3.3 Ending an All Call.....	24



6.4 Broadcast Call (Trunking Only).....	24
6.4.1 Initiating a Broadcast Call.....	24
6.4.2 Receiving a Broadcast Call.....	25
6.4.3 Ending a Broadcast Call.....	25
6.5 Include Call (Trunking Only).....	26
6.6 Phone Call.....	26
6.6.1 Initiating a Phone Call.....	26
6.6.2 Receiving a Phone Call.....	27
6.6.3 Ending a Phone Call.....	27
6.7 Call on Analog Channel (Conventional Only).....	28
6.7.1 Call without Signaling.....	28
6.7.2 Call with Signaling.....	28
<b>7. Message Services.....</b>	<b>29</b>
7.1 Sending a New Message.....	29
7.1.1 Through Message.....	29
7.1.2 Through Contact.....	29
7.1.3 Through Call Logs.....	29
7.2 Replying to a Message.....	30
7.3 Managing a Message.....	30
<b>8. General Features.....</b>	<b>31</b>
8.1 Settings.....	31
8.1.1 Basic Settings.....	31
8.1.2 Call Settings.....	33
8.1.3 Security.....	35
8.1.4 Product Information.....	39
8.2 Contacts.....	39
8.2.1 Creating a Contact.....	39
8.2.2 Managing a Favorite Contact.....	40
8.3 Profiles.....	40
8.3.1 Switching the Profile.....	40
8.3.2 Setting the Alert Tone.....	41
8.3.3 Audio Settings.....	41
8.4 Scan.....	42
8.4.1 Conventional Mode.....	42
8.4.2 Trunking Mode.....	43
8.5 Positioning.....	44
8.5.1 Enabling the Positioning Feature.....	44
8.5.2 Selecting the Positioning System.....	44
8.5.3 Viewing the Position.....	45
8.5.4 Sending a Position Message.....	45

8.5.5 Call Location .....	45
8.6 BT .....	46
8.6.1 Connecting a BT Device .....	47
8.6.2 BT Audio Switch.....	47
8.6.3 Setting the BT .....	47
8.7 One Touch Call/Menu .....	47
8.8 Quick Dial .....	48
8.9 Roam .....	49
8.9.1 Conventional Mode .....	49
8.9.2 Trunking Mode .....	50
8.10 Clarity Transmission .....	50
8.10.1 Conventional Mode .....	50
8.10.2 Trunking Mode .....	50
8.11 DGNA .....	50
8.12 Ignition Sense .....	51
8.13 Public Address .....	51
8.14 Priority Interrupt .....	51
8.14.1 Manual Priority Interrupt .....	52
8.14.2 Auto Priority Interrupt .....	52
8.15 Emergency.....	52
8.15.1 Initiating an Emergency Call .....	53
8.15.2 Receiving an Emergency Call.....	53
8.15.3 Ending an Emergency Call .....	53
8.16 Horn & Lights .....	53
8.17 Emergency Erase Data.....	54
8.18 Stun, Revive, and Kill.....	54
8.18.1 Conventional Mode.....	54
8.18.2 Trunking Mode .....	54
<b>9. Troubleshooting .....</b>	<b>55</b>
<b>10. Care and Cleaning .....</b>	<b>31</b>
10.1 Product Care.....	31
10.2 Product Cleaning .....	31
<b>11. Optional Accessories.....</b>	<b>32</b>
<b>12. Abbreviations .....</b>	<b>34</b>



# Documentation Conventions

## Icon Conventions

Icon	Description
 NOTE	Indicates references that can further describe the related topics.
 CAUTION	Indicates situations that could cause data loss or equipment damage.
 DANGER	Indicates situations that could cause major personal injury or even death.

## Notation Conventions

Item	Description	Example
<b>Boldface</b>	Denotes menus, tabs, parameter names, window names, dialogue names, and hardware buttons.	To save the configuration, click <b>Apply</b> .
		The <b>Log Level Settings</b> dialogue box appears.
		Press the <b>PTT</b> key.
" "	Denotes messages, directories, file names, folder names, and parameter values.	The screen displays "Invalid Battery!".
		Open "PSS.exe".
		Go to "D:/opt/local".
>	Directs you to access a multi-level menu.	In the Port text box, enter "22".
		Go to <b>File &gt; New</b> .
<i>Italic</i>	Denotes document titles.	For details about using the DWS, refer to <i>Dispatch Workstation User Guide</i> .
Courier New	Denotes commands and their execution results.	To set the IP address, run the following command:  vos-cmd - m name IP

# 1. Packing List

Please unpack carefully and check that you have received the following items. If any item is missing or damaged, contact your dealer.

Item	Quantity (PCS)	Item	Quantity (PCS)
Radio	1	Locking Knob	2
Mounting Bracket	1	Microphone Hanger	1
Palm Microphone Without Keypad (conventional) or with Keypad (trunking)	1	Screw (4 mm x 16 mm)	3
Screw (4.8 mm x 20 mm)	4	Power Cord (with fuse)	1
Documentation Kit	1	/	/

---

## NOTE

- Figures in this manual are for reference only.
  - Check whether the frequency band marked on the antenna label matches that on the radio label. If not, contact your dealer.
-

## 2. Product Overview

### 2.1 Product Layout

#### 2.1.1 Front Panel

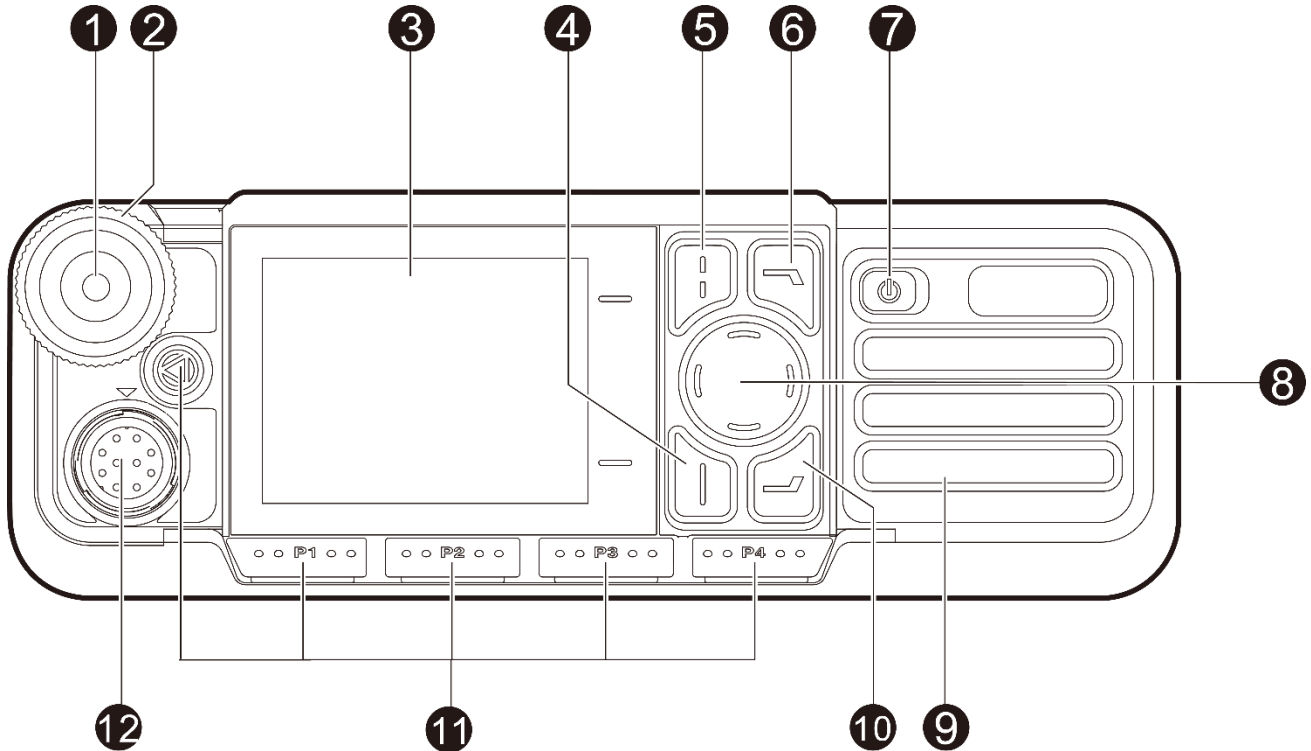

No.	Part Name	No.	Part Name
1	Smart Knob (Volume Control & Channel/Group Selector Knob)	7	On-Off Key
2	LED Indicator	8	Navigation Key
3	LCD Display	9	Speaker
4	OK/Menu Key	10	P5/Answer Key
5	Back/Subgroup Key	11	Programmable Keys
6	P6/End Key	12	Aviation Port

## 2.1.2 Rear Panel

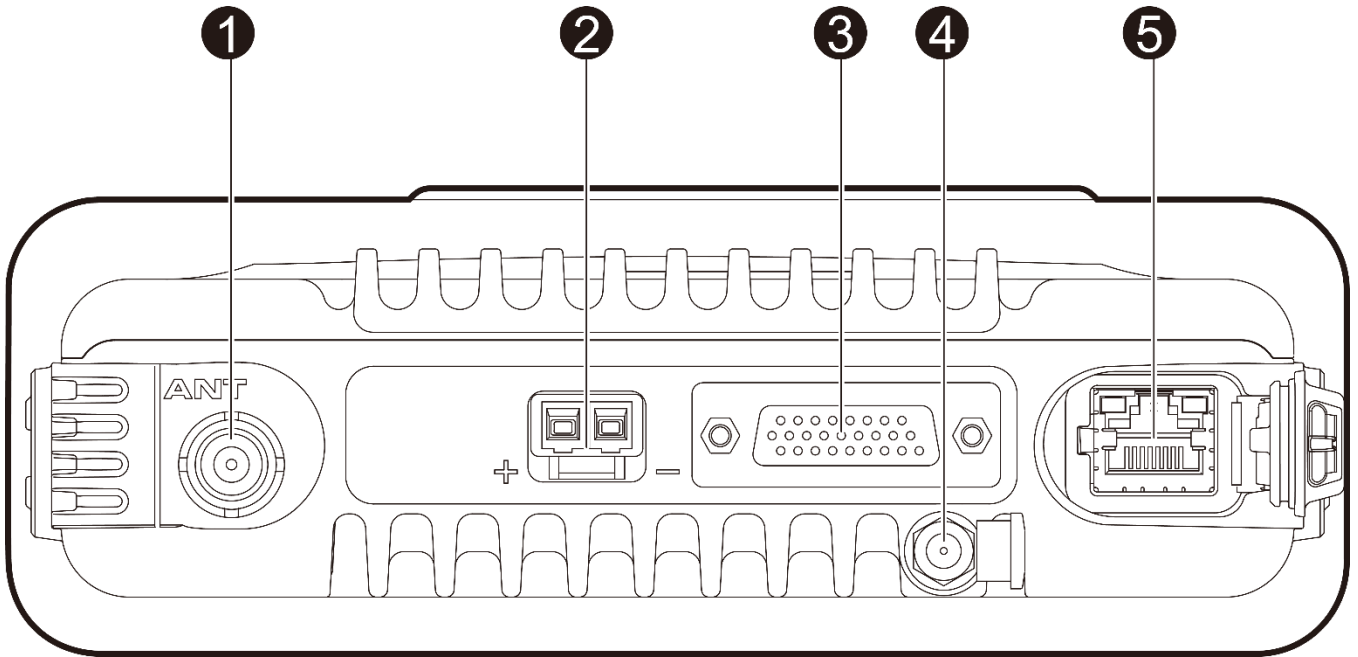

No.	Part Name	No.	Part Name
1	RF Antenna Connector	4	GPS Antenna Connector
2	Power Inlet	5	Network Port
3	Accessory Connector	/	/

**NOTE**

The GPS antenna connector is used only by radios with the GPS feature.

## 2.1.3 Palm Microphone

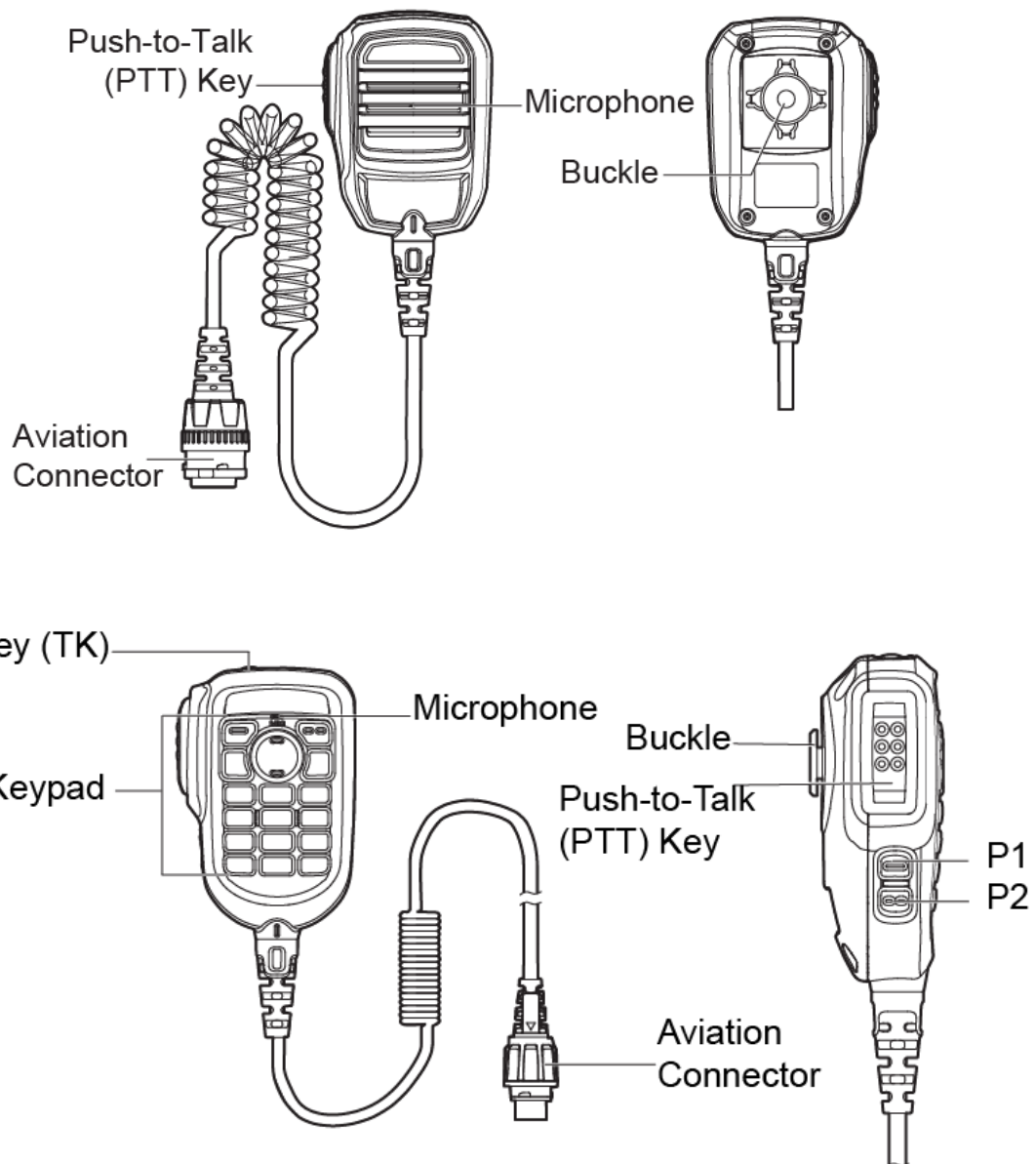

---

### NOTE

The palm microphone without keypad is available for the conventional radio and the one with keypad is for the trunking radio.

---

## 2.2 Programmable Keys

You can request your dealer to program the following keys as shortcuts to assignable radio features:

- Mobile radio: **TK**, **P1** key, **P2** key, **P3** key, **P4** key, **P5/Answer** key, and **P6/End** key.
- Palm microphone with keypad: **TK**, **P1** key, and **P2** key.

## 3. Installation

### 3.1 Instructions

Before installing the radio in a vehicle, read the following instructions carefully:

- Before installation, check the ground polarity and voltage of the vehicle power. The radio must work with a 13.6 V±15% negative ground electrical system.
- Before installation, check how long the screws will extend from the bottom surface of the radio. Drill the mounting hole cautiously to avoid damage to the vehicle wiring and other parts.
- Before you install the radio in the mounting bracket, connect the antenna and power cord to the radio. Use the dedicated antenna and power cord provided by the Company for digital radios.
- Install the radio with the mounting bracket supplied by the Company, to avoid accidental radio looseness. The loose radio may cause bodily injury.
- Install the radio in a location where you can reach the front panel conveniently.
- Keep sufficient clearance at the back of the radio for wiring.
- Use the fuse with the same specification for DC power cord upon replacement.
- If any other devices are in the vicinity of the radio, keep the antenna of these devices at least 10 m away from that of the radio.

### 3.2 Tools

- Electric drill
- Phillips screwdriver
- T20 torx screwdriver

### 3.3 Parts

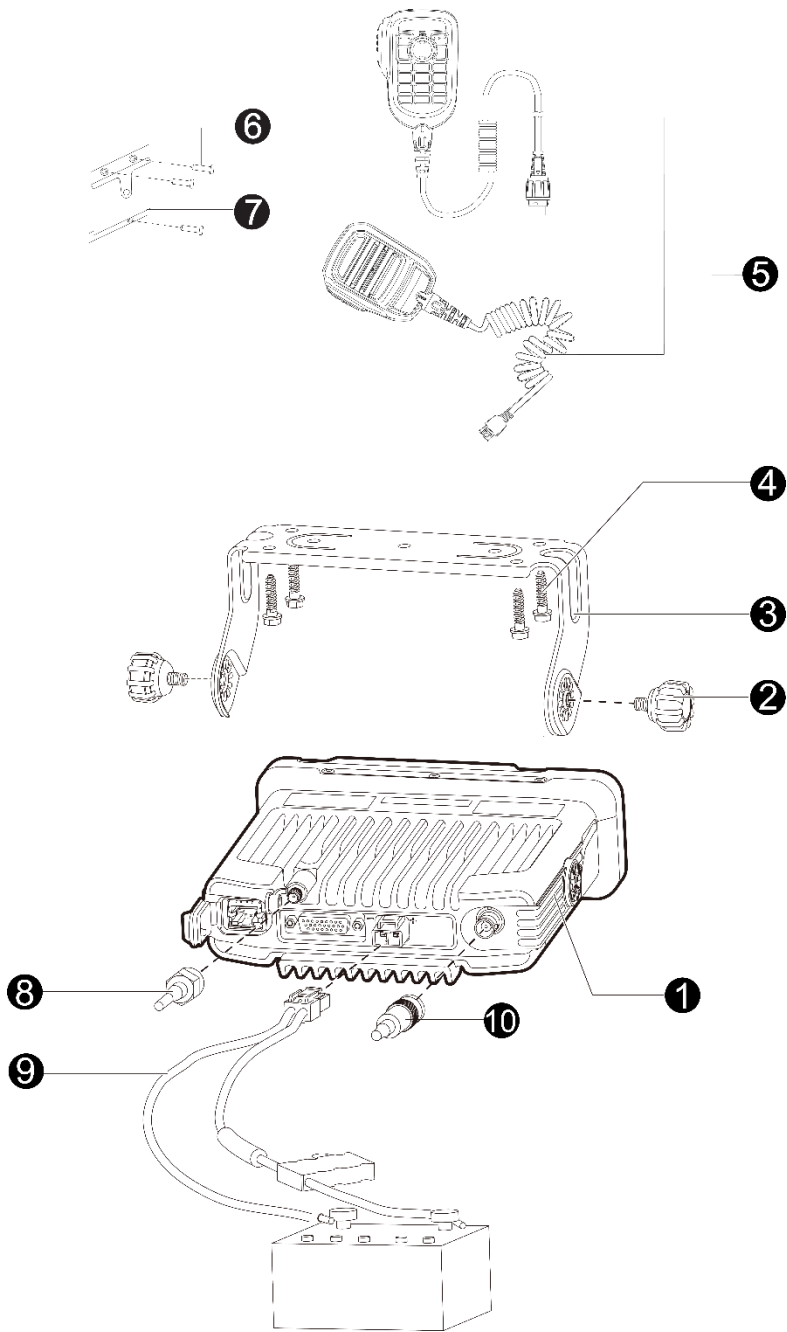

No.	Part Name	No.	Part Name
1	Radio	6	Screw (4 mm x 16 mm)
2	Locking Knobs	7	Microphone Hanger
3	Mounting Bracket	8	GPS Antenna
4	Screw (4.8 mm x 20 mm)	9	Power Cord (with fuse)
5	Palm Microphone	10	RF Antenna

---

**NOTE**

- The RF antenna must be purchased separately.
  - The GPS antenna is available only for radios with the GPS feature.
  - The palm microphone without keypad (with ⑥ and ⑦) is available for the conventional radio, and the one with keypad (with ⑥ and ⑦) is for the trunking radio.
- 

## 3.4 Procedure

### 3.4.1 Installing the TF Card

1. Release the latch on both sides of the plastic upper cover.

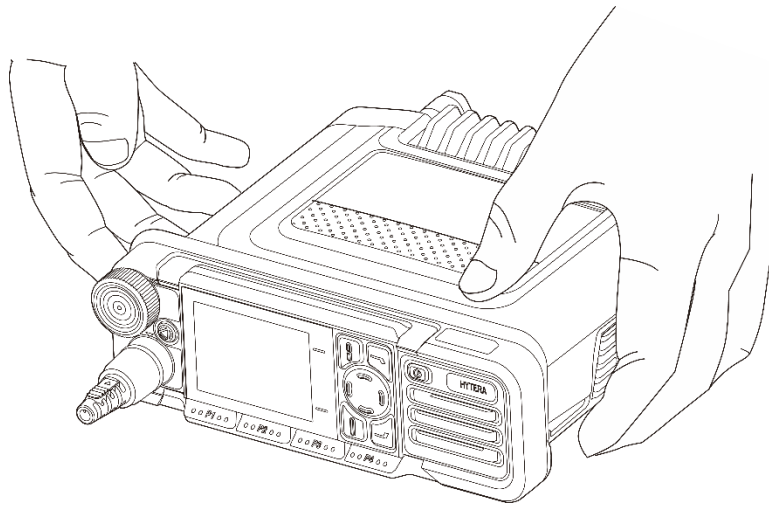

2. Hold the front panel, and then pull and remove the plastic upper cover.

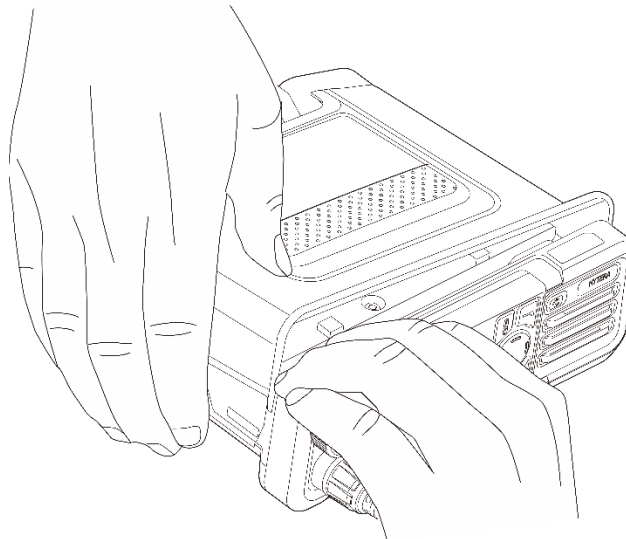

3. Insert the TF card to the metal card slot properly as directed in the following figure.



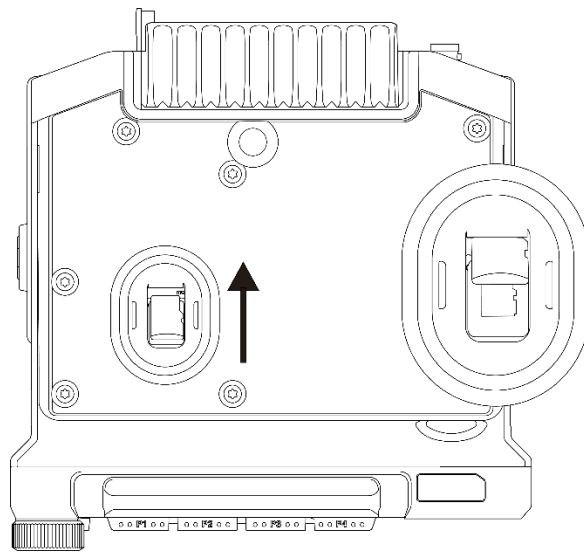

4. Align the concave side of the plastic upper cover with the aluminum chassis, and then press the cover until the latches are properly locked.

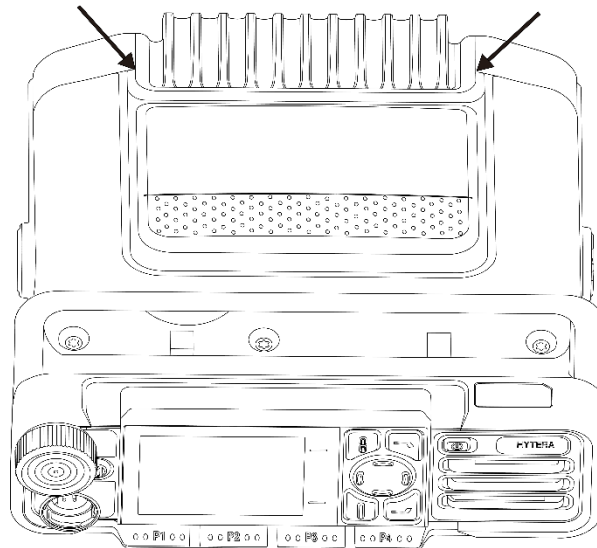

### 3.4.2 Installing the Radio

1. Select a location, drill holes based on the shape of the mounting bracket, and then use the screws (4.8 mm x 20 mm) to secure the bracket.
2. Connect the RF antenna, GPS antenna, and power cord to the radio.
3. Slide the radio into the mounted bracket, and then secure it by using the locking knobs.
4. Install the microphone hanger in a location where you can reach it easily, and then use the screws (4 mm x 16 mm) to secure it.
5. Align the triangle index on the palm microphone with the installation index, plug the connector into the radio, and then rotate the connector clockwise to secure it.
6. Place the palm microphone on the hanger.

## 4. Basic Operations

### 4.1 Turning On or Off the Radio

- To turn on the radio, long press the **On-Off** key.
- To turn off the radio, press the **On-Off** key.

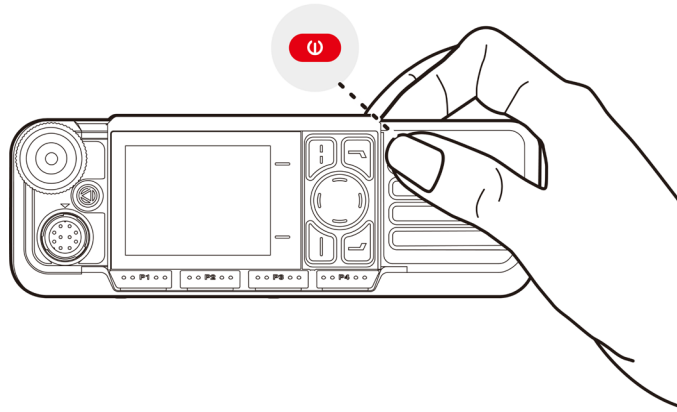

### 4.2 Adjusting the Volume

To increase or decrease the volume, rotate the **Smart** knob clockwise or counter-clockwise.

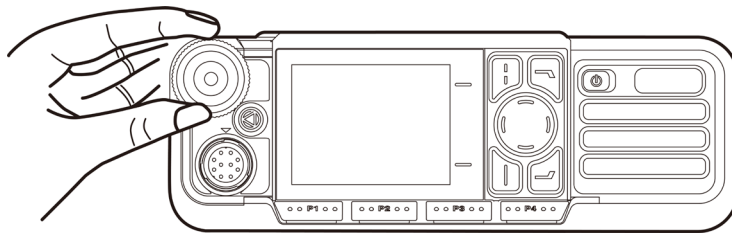

### 4.3 Switching the Operation Mode

The radio can operate in conventional mode, or digital/analog trunking mode (enabled by your dealer).

To manually switch the operation mode, do one of the following:

- Go to **Menu > Mode**, press the **Navigation** key up or down to select the mode, and then press the **OK/Menu** key.
- Press the preprogrammed **Operation Mode Switch** key.

To allow the radio to automatically switch to a mode based on signal strength, do one of the following:

- Go to **Menu > Mode > Auto Switch**, and then press the **OK/Menu** key to enable **Auto Switch**.
- Press the preprogrammed **Mode Auto Switch** key.

#### 4.3.1 Conventional Mode

In conventional mode, a zone is a group of channels within the same operational area. The radio receives and transmits data and voice on the selected channel after you select a zone and channel. Before selecting a channel, ensure that the

current zone contains the channel.

### 4.3.1.2 Selecting a Zone Through Menu

1. Go to **Menu > Zone**.
2. Press the **Navigation** key up or down to select the zone.
3. Press the **OK/Menu** key.

### Through Programmable Key

Press the preprogrammed **Zone Up** or **Zone Down** key.

### 4.3.1.3 Selecting a Channel Through Smart Knob

On the home screen, press the **Smart** knob, and then rotate the knob within 5s.

### Through Menu

1. Go to **Menu > Zone**.
2. Press the **Navigation** key up or down to select the zone.
3. Press the **Navigation** key up or down to select the channel.
4. Press the **OK/Menu** key.

### Through Programmable Key

- Press the preprogrammed **Channel Up** or **Channel Down** key.
- Press the preprogrammed **Preset Channel** key.

---

#### NOTE

If the Voice Notify feature is enabled by your dealer, the radio announces the channel number upon channel switching.

---

## 4.3.2 Trunking Mode

In trunking mode, the radio communicates with a group, private contact, and subgroup after registering with the base station.

### 4.3.2.1 Selecting a Group or Private Contact Through Smart Knob

On the home screen, press the **Smart** knob, and then rotate the knob within 5s.

### Through Menu

1. On the home screen, press the **Back/Subgroup** key, or go to **Menu > Subgroup**.

2. Press the **Navigation** key up or down to select the subgroup.
3. Press the **Navigation** key up or down to select the group or private contact.
4. Press the **OK/Menu** key.

### Through Programmable Key

Press the preprogrammed **Group/Private Up** or **Group/Private Down** key.

#### 4.3.2.2 Selecting a Subgroup

A subgroup consists of multiple groups or private contacts.

### Through Menu





















1. On the home screen, press the **Back/Subgroup** key, or go to **Menu > Subgroup**.
2. Press the **Navigation** key up or down to select the subgroup.
3. Press the **OK/Menu** key.















### Through Programmable Key

Press the preprogrammed **Subgroup Up** or **Subgroup Down** key.

# 5. Status Indications

## 5.1 LCD Icons

Icon	Radio Status
	The radio detects no signal.
	The number of bars indicates the signal strength.
	The radio operates in low power mode.
	The radio operates in high power mode.
	An accessory is connected.
	The GPS feature is enabled, and valid positioning data has been received.
	The GPS feature is enabled, but no valid positioning data has been received.
	The BT feature is enabled.
	A BT device is connected.
	The Mode Automatic Switch feature is enabled.
	The radio is in emergency mode.
	The radio stays on a site.
	The radio is roaming.
	The Scrambler or Encrypt feature is enabled.
	The Over the Air Encrypt feature is enabled.
	The radio is scanning.
	The radio stays on an active channel.
	The radio stays on Priority Channel 1.
	The radio stays on Priority Channel 2.
	The radio has switched to the mixed channel.
	The TF card is abnormal.

	The TF card is nearly full.
	The TF card is full.
	The radio is recording the call.
	The radio fails to recording the call.
	The Voice Operated Transmit (VOX) feature is enabled.
	The Monitor feature is enabled.
	The speaker is unmuted.
	The radio operates in silent mode.
	The radio operates in profile 1.
	The radio operates in profile 2.
	The radio operates in profile 3.
	There is/are new/unread message(s).
	The inbox is full.
	There is/are missed call(s).
	The Call Divert feature is enabled.

## 5.2 LED Indicators

LED Indicator	Radio Status
Flashes green	The radio is being turned on.
Flashes green slowly	The radio is standby in trunking mode.
Glow green	The radio is receiving.
Glow red	The radio is transmitting.
Flashes red	The radio is establishing a call in trunking mode. This indication is applicable only to the calling radio.
Flashes orange slowly	<ul style="list-style-type: none"> <li>● Conventional mode: The radio is scanning or roaming.</li> <li>● Trunking mode: The radio is scanning.</li> </ul>

Flashes orange rapidly	<ul style="list-style-type: none"> <li>● Conventional mode: The radio is operating in Emergency mode.</li> <li>● Trunking Mode: The radio is establishing a Full Off Air Call Set-up (FOACSU) private call. This indication is applicable only to the called radio.</li> </ul>
Glow orange	Call hang time: No voice is being transmitted or received during a call. Within such a period, you can press and hold the <b>PTT</b> key and speak.
Flashes blue every 3s	The BT feature is enabled, but no BT device is connected.
Flashes blue every 1.5s	A BT device is connected.
Flashes blue every 0.1s	The BT feature is being disabled.

## 6. Call Services

When you are speaking during a call, keep the microphone 2.5 to 5 cm away from your mouth. This ensures optimal voice quality on the receiving radio.

---

### NOTE

In trunking mode, if the radio is not registered or attached, or an empty group is selected, you cannot initiate a call.

---

## 6.1 Group Call

A group call is a call from an individual user in a group to all the other members in the group.

---

### NOTE

In trunking mode, with the Auto Select Available Site feature enabled by your dealer, the radio automatically registers with an unrestricted BS for successful call establishment with the restricted group.

---

### 6.1.1 Initiating a Group Call

#### 6.1.1.1 Conventional Mode Through Preset Contact

1. Press and then rotate the **Smart** knob to select the digital channel.
2. Press and hold the **PTT** key.

#### Through Contact List

1. Do either of the following:
  - Press the preprogrammed **Contact List** or **Favorite Contact List** key.
  - Go to **Menu > Contact > Favorite/Contact**.
2. Select the group contact.
3. Press and hold the **PTT** key.

#### Through Manual Dialing

If the radio is connected to the palm microphone with keypad, do either of the following:

- With the group call dial permission enabled by your dealer, on the home screen, enter the group ID, select **Group ID**, and then press and hold the **PTT** key.
  - With the Keypad Mode feature enabled by your dealer, go to **Menu > Settings > Basic Settings > Keypad Mode**, and then select **On**. On the home screen, enter the group ID, select **Group ID**, and then press and hold the **PTT** key.
- 

### NOTE

The group ID must be complied with the dialing rules. For details, consult your dealer.

---



## Through One Touch Call/Menu

With the One Touch Call/Menu feature enabled, press the preprogrammed **One Touch Call/Menu** key, and then press and hold the **PTT** key.

### 6.1.1.2 Trunking Mode Through Preset Contact

1. Press and then rotate the **Smart** knob to select the group contact.
2. Press the **PTT** key.

### Through Contact List

1. Do either of the following:
  - Press the **Back/Subgroup** key or the preprogrammed **Current Subgroup Contact** key, and then select the subgroup and group contact.
  - Press the preprogrammed **Contact List** key, or go to **Menu > Contact > Favorite/Private**, and then select the group contact.
2. Press the **P5/Answer** key on the radio, or press the **Answer** key or the **PTT** key on the palm microphone.

### Through Manual Dialing

1. On the home screen, enter the group ID through the keypad on the palm microphone.
2. Do either of the following:
  - Press the **P5/Answer** key on the radio.
  - Press the **Answer** key, **#†**, or the **PTT** key on the palm microphone.

---

#### NOTE

The group ID must be complied with the dialing rules. For details, consult your dealer.

---

### Through Call Logs

1. Do one of the following:
  - Go to **Menu > Call Logs**.
  - Press the preprogrammed **BackDial Call** or **ReDial Call** key.
2. Select the group call record.
3. Press the **P5/Answer** key on the radio, or press the **Answer** key or the **PTT** key on the palm microphone.

## Through One Touch Call/Menu

With the One Touch Call/Menu feature enabled, press the preprogrammed **One Touch Call/Menu** key.

## 6.1.2 Receiving a Group Call

You can answer a group call without any operation.

## 6.1.3 Ending a Group Call

- Conventional mode

A group call ends when the call hang time expires.

- Trunking mode

A group call ends in any of the following cases:

- The calling party presses the **P6/End** key or place the palm microphone back to the hanger.
- The call duration preset by your dealer expires.
- The base station signal is lost.
- A preemptive or emergency call interrupts the call.
- The calling party changes the contact with the Clear Down feature enabled.

## 6.2 Private Call

A private call is a call from an individual user to another individual user.

### 6.2.1 Initiating a Private Call

#### 6.2.1.1 Conventional Mode

##### Through Preset Contact

1. Press and then rotate the **Smart** knob to select the digital channel.
2. Press and hold the **PTT** key.

##### Through Contact List

1. Do either of the following:
  - Press the preprogrammed **Contact List** or **Favorite Contact List** key.
  - Go to **Menu > Contact/Favorite**.
2. Select the private contact.
3. Press and hold the **PTT** key.

##### Through Manual Dialing

If the radio is connected to the palm microphone with keypad, do either of the following:

- With the private call dial permission enabled by your dealer, on the home screen, enter the private ID, select **Private ID**, and then press and hold the **PTT** key.

- With the Keypad Mode feature enabled by your dealer, go to **Menu > Settings > Basic Settings > Keypad Mode**, and then select **On**. On the home screen, enter the private ID, select **Private ID**, and then press and hold the **PTT** key.

---

 **NOTE**

The private ID must be complied with the dialing rules. For details, consult your dealer.

---

## Through Call Logs

1. Go to **Menu > Call Logs**, and then select the private call record.
2. Press and hold the **PTT** key.

## Through One Touch Call/Menu

With the One Touch Call/Menu feature enabled, press the preprogrammed **One Touch Call/Menu** key, and then press and hold the **PTT** key.

### 6.2.1.2 Trunking Mode

#### Through Preset Contact

1. Press and then rotate the **Smart** knob to select the private contact.
2. Press the **PTT** key.

#### Through Contact List

1. Do either of the following:
  - Press the **Back/Subgroup** key or the preprogrammed **Current Subgroup Contact** or **Contact List** key.
  - Go to **Menu > Contact > Favorite/Private**.
2. Select the private contact.
3. Press the **P5/Answer** key on the radio, or press the **Answer** key or the **PTT** key on the palm microphone.

#### Through Manual Dialing

1. On the home screen, enter the private ID through the keypad on the palm microphone.
2. Do either of the following:
  - Press the **P5/Answer** key on the radio.
  - Press the **Answer** key, , or the **PTT** key on the palm microphone.

---

 **NOTE**

The private ID must be complied with the dialing rules. For details, consult your dealer.

---

## Through Call Logs

1. Do one of the following:

- Go to **Menu > Call Logs**.
  - Press the preprogrammed **BackDial Call** or **ReDial Call** key.
2. Select the private call record.
  3. Press the **P5/Answer** key on the radio, or press the **Answer** key or the **PTT** key on the palm microphone.

## Through One Touch Call/Menu

With the One Touch Call/Menu feature enabled, press the preprogrammed **One Touch Call/Menu** key.

### 6.2.2 Receiving a Private Call

- Conventional mode

You can answer a private call without any operation.

- Trunking mode

You can answer a private call through either of the following ways:

- FOACSU

When receiving a FOACSU private call, the radio rings and vibrates. To answer the call, press the **P5/Answer** key on the radio, the **Answer** key, or the **PTT** key on the palm microphone within the preset time period:

- Off Air Call Set-Up (OACSU)

When receiving an OACSU private call, you can answer the call without any operation.

### 6.2.3 Ending a Private Call

- Conventional mode

A private call ends when the call hang time expires.

- Trunking mode

A private call ends in any of the following cases:

- The calling or called party presses the **P6/End** key or places the palm microphone back to the hanger.
- The call duration preset by your dealer expires.
- The base station signal is lost.
- A preemptive or emergency call interrupts the call.
- The calling or called party changes the contact with the Clear Down feature enabled.

## 6.3 All Call

- Conventional mode

An all call is a call from an individual user to all the other users on the current digital channel.

- Trunking mode

An all call is a call from an individual user to all the other users in the network.

An all call can be either of the following types:

- Broadcast All Call: Only the calling party can transmit voice.
- General All Call: Both the calling party and the called party can transmit voice.

To select the all call type, go to **Menu > Settings > Call Settings > All Call**, and then select **Broadcast Call** or **General Call**.



The All Call feature is enabled by your dealer.

---

## 6.3.1 Initiating an All Call

### 6.3.1.1 Conventional Mode Through Preset Contact

1. Press and then rotate the **Smart** knob to select the all call contact preset for the digital channel.
2. Press and hold the **PTT** key.

### Through Contact List

1. Do either of the following:
  - Press the preprogrammed **Contact List** or **Favorite Contact List** key.
  - Go to **Menu > Contact/Favorite**.
2. Select the all call contact.
3. Press and hold the **PTT** key.

### Through One Touch Call/Menu

With the One Touch Call/Menu feature enabled, press the preprogrammed **One Touch Call/Menu** key, and then press and hold the **PTT** key.

### 6.3.1.2 Trunking Mode Through Manual Dialing

1. On the home screen, enter the all call ID through the keypad on the palm microphone.
2. Do either of the following:
  - Press the **P5/Answer** key on the radio.
  - Press the **Answer** key, **#\***, or the **PTT** key on the palm microphone.

---

 **NOTE**

The all call ID must be complied with the dialing rules. For details, consult your dealer.

---

## Through Call Logs

1. Press the preprogrammed **BackDial Call** or **ReDial Call** key.
2. Select the all call record.
3. Press the **P5/Answer** key on the radio, or press the **Answer** key or the **PTT** key on the palm microphone.

## Through One Touch Call/Menu

With the One Touch Call/Menu feature enabled, press the preprogrammed **One Touch Call/Menu** key.

### 6.3.2 Receiving an All Call

You can answer an all call without any operation.

### 6.3.3 Ending an All Call

- Conventional mode

An all call ends when the calling party releases the **PTT** key.

- Trunking mode

A private call ends in any of the following cases:

- The calling party presses the **P6/End** key or places the palm microphone back to the hanger.
- The call duration preset by your dealer expires.
- The base station signal is lost.
- The calling party changes the contact with the Clear Down feature enabled.

## 6.4 Broadcast Call (Trunking Only)

A broadcast call is a special group call, during which only the calling party can transmit voice.

---

 **NOTE**

The Broadcast Call feature is enabled by your dealer.

---

### 6.4.1 Initiating a Broadcast Call

#### 6.4.1.1 Through Contact List

1. Do either of the following:
  - Press the **Back/Subgroup** key or the preprogrammed **Current Subgroup Contact** key, and then select the subgroup and group contact.

- Press the preprogrammed **Favorite Contact List** key, or go to **Menu > Contact > Favorite**, and then select the group contact.
2. Set the call type to **Broadcast Call**.
3. Press the **P5/Answer** key on the radio, or press the **Answer** key or the **PTT** key on the palm microphone.

### 6.4.1.2 Through Manual Dialing

1. On the home screen, enter the broadcast call ID through the keypad on the palm microphone.
2. Do either of the following:
  - Press the **P5/Answer** key on the radio.
  - Press the **Answer** key, **#\***, or the **PTT** key on the palm microphone.

---

#### NOTE

The broadcast call ID must be complied with the dialing rules. For details, consult your dealer.

---

### 6.4.1.3 Through Call Logs

1. Do one of the following:
  - Go to **Menu > Call Logs**.
  - Press the preprogrammed **BackDial Call** or **ReDial Call** key.
2. Select the group call record, and then set the call type to **Broadcast Call**.
3. Press the **P5/Answer** key on the radio, or press the **Answer** key or the **PTT** key on the palm microphone.

### 6.4.1.4 Through One Touch Call/Menu

With the One Touch Call/Menu feature enabled, press the preprogrammed **One Touch Call/Menu** key.

## 6.4.2 Receiving a Broadcast Call

You can answer a broadcast call without any operation.

## 6.4.3 Ending a Broadcast Call

A broadcast call ends in any of the following cases:

- The calling party presses the **P6/End** key or places the palm microphone back to the hanger.
- The call duration preset by your dealer expires.
- The base station signal is lost.
- A preemptive or emergency call interrupts the call.
- The calling party changes the contact with the Clear Down feature enabled.

## 6.5 Include Call (Trunking Only)

An include call is a special group call during which another group is invited during the call hang time. An include call has the same Talk Priority and Clear Down feature as a group call.

The Include Call feature is enabled by your dealer.

For operations of initiating, receiving, or ending an include call, see [6.1 Group Call](#).

## 6.6 Phone Call

A phone call is a call made from the radio to a phone through a repeater after the repeater accesses the PSTN/PABX system through a PSTN/PABX gateway.

### 6.6.1 Initiating a Phone Call

#### 6.6.1.1 Conventional Mode Through Contact List

1. Press the preprogrammed **Contact List** or **Favorite Contact List** key, or go to **Menu > Contact/Favorite**.
2. Select the phone contact.
3. Press and hold the **PTT** key.

#### Through Manual Dialing

With the phone call dial permission enabled by your dealer, do as follows:

1. On the home screen, enter the phone ID, and then select **DTMF Dial**.
2. Press and hold the **PTT** key.



#### NOTE

The phone ID must be complied with the dialing rules. For details, consult your dealer.

---

#### 6.6.1.2 Trunking Mode Through Contact List

1. Press the preprogrammed **Favorite Contact List** key, or go to **Menu > Favorite/Private**.
2. Select the PSTN/PABX contact.
3. Press the **P5/Answer** key on the radio, or press the **Answer** key or the **PTT** key on the palm microphone.

#### Through Manual Dialing

1. On the home screen, enter the phone ID through the keypad on the palm microphone.
2. Select **PSTN/PABX**.
3. Do either of the following:



- Press the **P5/Answer** key on the radio.
- Press the **Answer** key, **#\***, or the **PTT** key on the palm microphone.

---

#### NOTE

The phone ID must be complied with the dialing rules. For details, consult your dealer.

---

## Through Call Logs

1. Do one of the following:
  - Go to **Menu > Call Logs**.
  - Press the preprogrammed **BackDial Call** or **ReDial Call** key.
2. Select the PSTN/PABX call record.
3. Press the **P5/Answer** key on the radio, or press the **Answer** key or the **PTT** key on the palm microphone.

## Through One Touch Call/Menu

With the One Touch Call/Menu feature enabled, press the preprogrammed **One Touch Call/Menu** key.

### 6.6.2 Receiving a Phone Call

- Conventional mode

When receiving a phone call, press the **P5/Answer** key (with the One-Key Connect feature enabled) or enter the connect code to join the phone system. Then you can answer the phone call.

- Trunking mode

When receiving a PSTN/PABX call, press the **P5/Answer** key on the radio, or press the **Answer** key or the **PTT** key on the palm microphone within the preset time.

### 6.6.3 Ending a Phone Call

- Conventional mode

A phone call ends in either of the following cases:

- The calling party hangs up.
- The called party presses the **P6/End** key (with the One-Key Connect feature enabled) or enters the disconnect code.

- Trunking mode

A phone call ends in any of the following cases:

- The calling party presses the **P6/End** key or places the palm microphone back to the hanger.
- The call duration preset by your dealer expires.
- The base station signal is lost.

- A preemptive or emergency call interrupts the call.
- The calling party changes the contact with the Clear Down feature enabled.

## 6.7 Call on Analog Channel (Conventional Only)

### 6.7.1 Call without Signaling

On an analog channel without signaling, you can initiate a call to all the other users on the channel. Do as follows:

1. Rotate the **Smart** knob to select the channel.
2. Press and hold the **PTT** key on the palm microphone.

### 6.7.2 Call with Signaling

On an analog channel with signaling, you can initiate a call to a specific contact on the channel. Do as follows:

1. Go to **Menu > Contact > Favorite/Contact**, or press the preprogrammed **Contact List** key.
2. Select the contact.
3. Press and hold the **PTT** key or the preprogrammed **One Touch Call** key.

# 7. Message Services

In trunking mode or on a digital channel in conventional mode, the Message feature allows you to send and receive the following types of messages:

- Quick text message: a frequently used text message that can be created, edited, or deleted through the menu.
- Status message: a predefined code that transfers the message content.

## 7.1 Sending a New Message

### 7.1.1 Through Message

1. Go to **Menu > Message > Msg New > New Msg**.
2. Select the recipient in either of the following ways:
  - In the recipient text box, enter the contact number, and then press  to switch the number type.
  - Press the **OK/Menu** key to enter the contact list, and then select the contact.
3. Determine the message type.
  - To send a text message, enter the message content in the message text box.
  - To send a quick text message or status message (trunking only), press the **OK/Menu** key to select a message, and then press the **OK/Menu** key again to add the message.
4. Press the **OK/Menu** key to send the message.

### 7.1.2 Through Contact

1. Determine the operation mode.
  - If the radio operates in conventional mode, go to **Menu > Contact > Favorite/Contact**.
  - If the radio operates in trunking mode, go to **Menu > Contact > Favorite/Private**.
2. Select the contact.
3. Select **New Msg**, and then enter the message content.
4. Press the **OK/Menu** key to send the message.

### 7.1.3 Through Call Logs

1. Go to **Menu > Call Logs**, and then select the contact.
2. Press the **OK/Menu** key to select **Message**, and then enter the message content.

3. Press the **OK/Menu** key to send the message.

## 7.2 Replying to a Message

1. Go to **Menu > Message > Msg**.
2. Select a conversation, and then press the **OK/Menu** key twice.
3. Determine the message type.
  - To send a text message, enter the message content in the message text box.
  - To send a quick text message or status message (trunking only), press the **OK/Menu** key to select a message, and then press the **OK/Menu** key again to add the message.
4. Press the **OK/Menu** key to send the message.

## 7.3 Managing a Message

1. Go to **Menu > Message > Msg**.
2. Select a conversation, and then press the **OK/Menu** key.
3. Press the **Up** key to select a message, and then press the **OK/Menu** key to do either of the following:
  - Select **Forward**, press the **OK/Menu** key, and then select a recipient to forward the message.
  - Select **Resend**, **Delete**, or **Delete All**, and then press the **OK/Menu** key to perform the corresponding operations.

# 8. General Features

## 8.1 Settings

Go to **Menu > Settings**, and then set radio parameters including **Basic Settings**, **Call Settings**, and **Security**.

### 8.1.1 Basic Settings

#### 8.1.1.2 Language

Go to **Basic Settings > Language**, and then select the display language.

#### 8.1.1.3 Display

Go to **Basic Settings > Display**, and then set one of the following:

- Backlight

The backlight is designed to illuminate the display and keypad.

Go to **Backlight**, select **Off**, **On**, or **Timed**, and then press the **OK/Menu** key.

- Night mode

The display modes include day mode and night mode. The screen brightness and user interface vary with the display mode.

Go to **Night Mode** to switch between the two modes.

- Brightness

A smaller number of a level represents higher screen brightness.

Go to **Brightness**, select **Level 1**, **Level 2**, **Level 3**, or **Level 4**, and then press the **OK/Menu** key.

#### 8.1.1.4 Date & Time

The radio displays the local time by default. If no time data is received, the radio displays "--:--".

Go to **Basic Settings > Date & Time**, and then do one of the following:

- Select **Time Display**, and then enable or disable the display of time on the home screen, or in the call record and message interface.
- Select **Time View**, and then view the current **Time**, **Date**, and **Week**.
- Select **Time Set**, and then modify the **Hour/Minute/Second/Year/Month/Day** to be displayed.
- Select **Time Format**, and then set the format to **24 Hour** or **12 Hour**.

- Select **Time Zone**, and then set the time zone.

### 8.1.1.5 Keypad Mode

With the Keypad Mode feature enabled by your dealer, go to **Basic Settings > Keypad Mode**, and then do either of the following:

- Select **On** or **Off** to enable or disable the manual dialing on the home screen.
- Select **One Touch Call/Menu** to enable the One Touch Call/Menu feature by the numeric keypad.

### 8.1.1.6 MIC & SPK

The MIC & SPK feature allows you to select the microphone and speaker used by the radio to transmit and receive voice. With the audio accessory connected, you can switch the audio options. For details, see the following tables.

#### MIC

Option	Description	Operation
Follow PTT	When you transmit voice through the <b>PTT</b> key of the radio, the radio uses the internal microphone. When you transmit voice through the audio accessory, the radio uses the external microphone.	<ul style="list-style-type: none"> <li>● Through the menu               <ol style="list-style-type: none"> <li>1. Go to <b>Basic Settings &gt; MIC &amp; SPK</b>.</li> <li>2. Select <b>MIC Selection</b>.</li> <li>3. Select the audio option.</li> </ol> </li> <li>● Press the preprogrammed <b>Mic Set Switch</b> key to switch the audio option.</li> </ul>
Only Internal	The radio uses only the internal microphone.	
Only External	The radio uses only the microphone of the audio accessory, such as earpieces.	

#### SPK

Option	Description	Operation
Only Internal	The radio uses only the internal speaker.	<ul style="list-style-type: none"> <li>● Through the menu               <ol style="list-style-type: none"> <li>1. Go to <b>Basic Settings &gt; MIC &amp; SPK</b>.</li> <li>2. Select <b>SPK Selection</b>.</li> <li>3. Select the audio option.</li> </ol> </li> <li>● Press the preprogrammed <b>SPK Set Switch</b> key to switch the audio option.</li> </ul>
Only External	The radio uses only the speaker of the audio accessory, such as the remote speaker microphone.	
External First	When audio accessories are connected, the radio uses the external speaker. Otherwise, the radio uses the internal speaker.	

## 8.1.2 Call Settings

### 8.1.2.1 Power Level

You can set the TX power level to high or low.

Go to **Call Settings** > **Power Level**, select **High Power** or **Low Power**, and then press the **OK/Menu** key.

### 8.1.2.2 VOX

The Voice Operated Transmit (VOX) feature allows the voice to trigger transmission. When the voice detected by the microphone reaches the value to trigger transmission, the radio automatically transmits the voice without the **PTT** key pressed.

1. Go to **Call Settings** > **VOX**, and then press the **OK/Menu** key to enable the feature.
2. Select **External/Internal**, and then adjust the microphone transmission sensitivity.

A smaller number of a level represents higher sensitivity.

### 8.1.2.3 Talker Alias

With the Talker Alias feature enabled by your dealer, go to **Call Settings** > **TalkingAlias**, and then do either of the following:

- **Send Alias**

This feature allows you to send the radio alias during a call, so that the called party can identify the calling party by the alias.

Select **Send Alias**, and then press the **OK/Menu** key to enable or disable the feature.

- **Auto Add Contacts**

If both the calling party and the called party enable the **Auto Add Contacts** and **Send Alias** features, the called party automatically adds the calling party to the contact list when receiving the call.

In conventional mode, this feature is enabled by your dealer. In trunking mode, you can select **Auto Add Contact**, and then press the **OK/Menu** key to enable or disable the feature.

### 8.1.2.4 Talk Around (Conventional Only)

The Talk Around feature allows you to continue communication in direct mode when the repeater malfunctions or the radio is out of the repeater's coverage.

Go to **Call Settings** > **Talk Around**, and then press the **OK/Menu** key to enable or disable the feature.

### 8.1.2.5 Squelch Level (Conventional Only)

The squelch level refers to the squelch threshold required for the speaker of the radio to be turned on. The higher squelch level requires a stronger signal.

- Go to **Call Settings** > **Squelch**, select **Weak**, **Normal**, or **Tight**, and then press the **OK/Menu** key.
- Press the preprogrammed **Adjust Squelch Level** key to adjust the level.

### 8.1.2.6 Compandor (Conventional Only)

The Compandor feature allows the radio to compress the voice signal when transmitting and decompress the voice signal when receiving to improve the voice quality.

Go to **Call Settings** > **Compandor**, and then press the **OK/Menu** key to enable or disable the feature.

### 8.1.2.7 ESN Check in Idle (Trunking Only)

The ESN Check in Idle feature allows the radio to respond to the ESN check from the trunking system when the radio is registering or after the radio has registered.

Go to **Call Settings** > **ESN Check In Idle**, and then press the **OK/Menu** key to do either of the following:

- Enable the feature.

The radio responds to the ESN check both during registration and after registration.

- Disable the feature.

The radio responds to the ESN check only during registration.

### 8.1.2.8 Call Priority (Trunking Only)

The Call Priority feature allows you to set the priority of all voice services except emergency calls. The priority levels include **Low**, **Medium**, **High**, and **Preemption** (with the Preemptive Call feature enabled by your dealer).

When all channels are occupied, the call requests are put in a queue according to their priorities. When a channel is released, the call with a higher priority will be connected prior to the call with a lower priority.

During group call queuing, only the calling party receives the queuing prompt. During private call queuing, both the calling party and the called party receive queuing prompt. When the queue is full, the higher-priority calls can jump the queue, and the lower-priority calls will be extruded out (the system will prompt that it is busy) accordingly.

Go to **Call Settings** > **Priority**, select the priority level, and then press the **OK/Menu** key.



### 8.1.2.9 Any Call (Trunking Only)

The Any Call feature allows the radio to initiate a call to a contact whose ID is not in the contact list.

- Go to **Call Settings > Any Call**, and then press the **OK/Menu** key to enable or disable **Private ID**.
  - With **Private ID** enabled, you can call any private contacts.
  - With **Private ID** disabled, you can call only the private contacts in the contact list or emergency contact.
- Go to **Call Settings > Any Call**, and then press the **OK/Menu** key to enable or disable **Group ID**.
  - With **Group ID** enabled, you can call any group contacts except that of the background group.
  - With **Group ID** disabled, you can call only the group contacts in the contact list, dynamic group, or emergency contact.
- Go to **Call Settings > Any Call**, and then press the **OK/Menu** key to enable or disable **Phone**.
  - With **Phone** enabled, you can call any PABX/PSTN contacts.
  - With **Phone** disabled, you can call only the PABX/PSTN contacts in the contact list or emergency contact.

### 8.1.2.10 Call Divert (Trunking Only)

When the radio malfunctions or powers off, the Call Divert feature allows the radio to divert calls to a private or PABX/PSTN contact to ensure communications.

1. Go to **Call Settings > Call Divert**.
2. Go to **Divert ID**, and then enter the ID.
3. Go to **On/Off**, and then press the **OK/Menu** key to enable or disable the feature.

## 8.1.3 Security

### 8.1.3.1 Power-on Password

This feature allows you to set the power-on password of the radio.

1. Go to **Security > Power on Password**.
2. Go to **Password Set**, enter the initial password (88888888 by default), and then enter the new password.
3. Go to **On/Off**, and then press the **OK/Menu** key to enable or disable the feature.

---

 **NOTE**

If the password is entered incorrectly for the preset consecutive times, the radio cannot be used normally. Contact your dealer to reset the password.

---

### 8.1.3.2 Encrypt

The Encrypt feature provides end-to-end encryption for voice and data to protect them against eavesdropping.

#### Enabling or Disabling the Encrypt Feature

If the radio is configured with this feature, you can enable or disable it in either of the following ways:

- Go to **Security > Encrypt > On/Off**, and then press the **OK/Menu** key.
  - Press the preprogrammed **Encrypt** key.
- 

 **NOTE**

In conventional mode, the Encrypt feature is enabled for the current channel. When switching to the channel, the radio automatically enables encryption.

---

#### Setting the Encrypt Feature

- In conventional mode, you can add or select the encrypt key.

- Adding an Encrypt Key

Go to **Security > Encrypt > New Key**, specify the key-related parameters, and then press the **OK/Menu** key.

The following table describes the key-related parameters.

Parameter	Description
Key ID	The ID for each key must be unique. The value ranges from 1 to 255.
Key Alias	The key alias is composed of letters, digits, and special characters.
Key Length	The key length can be 10 characters, 32 characters, or 64 characters.
Key Value	The key value is composed of digits and letters and within the key length.

- Selecting the Encrypt Key

Go to **Security > Encrypt > Key List**, select the encrypt key, and then press the **OK/Menu** key.

- In trunking mode, you can select the encryption type.

Go to **Security > Encrypt > Encrypt Service**, set the encryption type to **Only Voice**, **Only Data**, or **Voice**

**and Data**, and then press the **OK/Menu** key.

### 8.1.3.3 Lone Worker

The Lone Worker feature allows the radio to automatically send an emergency alarm to your companion or the control center in either of the following scenarios:

- You do not operate the radio within the preset time.
- The radio does not transmit voice within the preset time.

You can press the keys, rotate the knob, or transmit voice to exit the emergency mode.

To enable or disable this feature, do either of the following:

- Go to **Security > Lone Worker**, and then press the **OK/Menu** key.
- Press the preprogrammed **Lone Worker** key.

### 8.1.3.4 TF Card

The TF card is used for encryption or audio recording.

#### TF Encryption

The TF Encryption feature allows the radio to encrypt the voice and data services with the TF card installed and the hardware encryption configured.

If the communication requires high security, you can customize the encryption algorithm and key and store them in the TF card.

#### Recorder

The Recorder feature allows you to record live sounds and calls to the TF card and manage the recording files stored in the TF card.

---

#### NOTE

The Recorder feature is enabled by your dealer.

---

- Live recording

The Live Record feature is to record the sound in the current environment. The maximum recording time is 495 minutes.

- Enabling the Live Record feature

Go to **Menu > TF Application > Recorder > Live Record**, and then press the **OK/Menu** key to enable the feature.

- Exiting the recording

- Press the **Back/Subgroup** key.
- The radio automatically exits the recording when other services with higher priority occurs or the storage of the TF card is insufficient.

- Call recording

The Call Record feature is to record the current call or all calls.

- Enabling the Call Record feature

- Press the preprogrammed **Call Record** key.
- Go to **Menu > TF Application > Recorder > Call Record**, and then press the **OK/Menu** key to enable the feature.

- Exiting the recording

- Press the **Back/Subgroup** key.
- Go to **Menu > TF Application > Recorder > Call Record**, and then press the **OK/Menu** key to disable the feature.
- The radio automatically exits the recording when other services with higher priority occurs or the storage of the TF card is insufficient.

- Recording file management

The File List feature allows you to manage recording files stored in **Record File List**. The file and file folder are described in the following table.

Item	Description	Naming Convention
Recording file	The maximum duration of each recording file is five minutes. If the duration exceeds the limit, the recording file is divided into several files.	<p>The recording file is named as "yyyy_mmddhhmmss.zz".</p> <ul style="list-style-type: none"> <li>● "x" can be "R" or "C", representing live record and call record respectively.</li> <li>● "yyy" is the number of a call.</li> <li>● "mmddhhmmss" represents the recording time (month/day/hour/minute/second).</li> </ul> <ul style="list-style-type: none"> <li>➤ In trunking mode, the time is the real time provided by the clock.</li> <li>➤ In conventional mode, the time is "0000000000".</li> </ul>

		<ul style="list-style-type: none"> <li>➤ "zz" represents the serial number of the files separated from a file.</li> </ul>
Recording file folder	Each folder can store up to 200 recording files.	<p>The folder is named as "Record_XXXX XXXX".</p> <p>The folder number "XXXX" ranges from 0001 to 9999.</p>

To manage the recording files, do one of the following:

- To play a recording file, select **Play**, and then press the **OK/Menu** key.
- To view the information of a recording file, select **View**, and then press the **OK/Menu** key.
- To delete a recording file, select **Delete**, and then press the **OK/Menu** key.
- To edit the name of a recording file, select **Edit**, enter the new name, and then press the **OK/Menu** key.

 **NOTE**

- With the Auto Cover feature enabled by your dealer, the radio automatically deletes the earliest recording file when the storage of the TF card is full.
- With the Compression feature enabled by your dealer, the radio compresses the recording file without affecting the audio quality to save the storage of the TF card.

## 8.1.4 Product Information

To check the product information, go to **Menu > Settings**, and then do one of the following:

- Select **Device Information**, and then press the **OK/Menu** key to check the information of TF card and capacity.
- Select **Radio Information**, and then press the **OK/Menu** key to check the radio ID, serial number, model name, frequency range, and so on.
- With the QR Code feature enabled by your dealer, select **QR Code**, and then scan the QR code to quickly obtain the radio information.

## 8.2 Contacts

### 8.2.1 Creating a Contact

#### 8.2.1.1 Through Contact Menu

Go to **Contact > New Contact**, enter the alias, private ID or phone number, and then press the **OK/Menu** key.

---

 **NOTE**

The ID and alias of each contact must be unique.

---

### 8.2.1.2 Through Call Logs

You can save a private ID to the contact list from the call logs.

Go to **Menu > Call Logs**, select **New Contact** or **Add To Contact**, and then press the **OK/Menu** key.

## 8.2.2 Managing a Favorite Contact

Go to **Menu > Contact > Favorite**, or press the preprogrammed **Favorite Contact List** key to enter the favorite contact list, and then do one of the following:

- Select the favorite contact to view details or delete it.
- Select **Edit** to add or delete favorite contacts.
- In trunking mode, go to **Edit > Add Folder**, and then do one of the following:
  - Select **Add Contact**, and then press the **OK/Menu** key to add favorite contacts.
  - Select **Add File**, and then press the **OK/Menu** key to add subfolders.
  - Select **Delete Folder**, and then press the **OK/Menu** key to delete the folder.
  - Select **Delete All Contact**, and then press the **OK/Menu** key to delete all the contacts in the current folder.
  - Select **Delete All File**, and then press the **OK/Menu** key to delete all subfolders.

## 8.3 Profiles

The Profiles feature allows you to set the audio, alert tone, and vibration of the radio for clear voice in various environments. The profiles include the following:

- General mode: applies to the low-noise environment, such as a quiet street.
- Meeting mode: applies to the indoor environment that is relatively quiet.
- Outdoor mode: applies to the high-noise environment, such as a highway.
- Customized mode: applies to other situations.

### 8.3.1 Switching the Profile

- Go to **Menu > Profiles**, select the profile, and then press the **OK/Menu** key.
- Press the preprogrammed **Profiles Switch** key.

## 8.3.2 Setting the Alert Tone

You can enable or disable the alert tone. Go to **Menu > Profiles > Settings > Tone > On/Off**, and then press the **OK/Menu** key.

After the alert tone is enabled, you can adjust the alert tone volume. Go to **Menu > Profiles > Settings > Tone > Tone Volume**, select the volume level, and then press the **OK/Menu** key.

A higher level represents higher volume.

## 8.3.3 Audio Settings

### 8.3.3.1 Mic AGC

The Mic AGC feature allows the calling radio to control the voice output gain within a proper range during transmission, so as to provide improved voice with proper volume for the called radio. This feature ensures stable voice even in noisy environment.

Go to **Menu > Profiles > Settings > Audio Set > Digital Mic AGC/Analog Mic AGC**, and then press the **OK/Menu** key to enable the feature.

### 8.3.3.2 3-Band Equalize

The 3-band Equalize feature allows the radio to adjust the balance between frequency components of the audio signal upon receiving voice. In this way, this feature optimizes the quality of the received voice, and meets user demands in different scenarios.

For optimal equalization, you can set the low/mid/high frequency gain according to different scenarios. The following table lists the recommended value for each parameter. You can also set the value as required.

Scenario	Low Frequency Gain (dB)	Mid Frequency Gain (dB)	High Frequency Gain (dB)
Standard	0	0	0
Meeting	-2	0	-6.5
Outdoor	-2	-3	6

Do as follows:

1. Go to **Menu > Profiles > Settings > Audio Set > 3-Band Equalize**, select **On**, and then press the **OK/Menu** key.
2. Set the **Low Freq. Gain**, **Mid Freq. Gain**, and **High Freq. Gain**. (The value range is from -8 dB to +8 dB.)

### 8.3.3.3 Noise Suppression

The Noise Suppression feature allows the radio to automatically eliminate ambient noise when receiving or transmitting voice. This feature enhances the voice clarity, while also decreases the volume.

With this feature enabled by your dealer, go to **Menu > Profiles > Settings > Audio Set > Noise Suppression**, and then press the **OK/Menu** key to enable the feature.

## 8.4 Scan



### 8.4.1 Conventional Mode

In conventional mode, the Scan feature allows you to listen to activities on other channels, keeping track of your team members.

#### 8.4.1.1 Enabling the Scan Feature

- Go to **Menu > Scan > Scan On/Off**, and then press the **OK/Menu** key.
- Press the preprogrammed **Scan** key.

With this feature enabled, the radio scans according to the scan list preset for the current channel. During the scanning, the LCD displays , and the LED indicator flashes orange slowly.

When detecting activities on a channel, the radio stays on the channel and the LED indicator glows green. If the radio stays on Priority Channel 1 or Priority Channel 2, the LCD displays  or . If the radio stays on a non-priority channel, the LCD displays .

---

#### NOTE

If you do not want to hear activities on the channel, press the preprogrammed **Nuisance Temporary Delete** key to remove the channel from the scan list temporarily.

---

#### 8.4.1.2 Setting the Scan List

The scan list is a list of up to 32 analog and digital channels that the radio scans.

Go to **Menu > Scan**, select the scan list, and then do one of the following:

- Select **Add CH**, and then press the **OK/Menu** key to add a new channel to the list.
- Select **Set Default**, and then press the **OK/Menu** key to set the list as the default scan list for the current channel.
- Select **View Record**, and then press the **OK/Menu** key to view or manage all channels on the current list.



---

 **NOTE**

If you do not need to scan, you can delete all channels other than the current channel. If you want to preferentially hear the activities on a channel, you can select the channel, and then select **Set PrioCH-1** or **Set PrioCH-2**.

---

## 8.4.2 Trunking Mode

### 8.4.2.1 Pre-registration Hunt

Before registering, the radio hunts through the control channels for available BSs. Two hunting plans are adoptable: Fixed Trunking Station Control Channel (Fixed TSCC) and Flexible Trunking Station Control Channel (Flexible TSCC). If the radio has unified frequency plans, it uses the Fixed TSCC; otherwise, it uses the Flexible TSCC. With the Fixed TSCC preset, you can select the hunt modes as listed in the following table.

Hunt Mode	Description	Operation
Short Hunt	This feature allows the radio to hunt the fixed TSCC in the defined hunt list.	Go to <b>Menu &gt; Scan &gt; TSCC Hunt</b> , select <b>Short Hunt</b> , <b>Comprehensive</b> , or <b>Team1</b> , and then press the <b>OK/Menu</b> key.
Comprehensive Hunt	This feature allows the radio to hunt all the channels within the preset frequency range.	
Team Hunt	This feature allows the radio to hunt the fixed TSCC in the defined team hunt list.	

### 8.4.2.2 Post-registration Hunt

After successful registration, you can hunt again by pressing the preprogrammed **Manual Current Hunt** key. To ensure seamless communications, you can enable the hunt modes as listed in the following table.

Hunt Mode	Description	Operation
Background Hunt	This feature allows an idle radio to keep detecting the signal strength of the BS with which it registers. If the signal strength goes below the threshold level preset by the dealer, the radio will automatically hunt for an adjacent BS with stronger signal strength and register with it.	<ul style="list-style-type: none"><li>Go to <b>Menu &gt; Scan</b>, and then press the <b>OK/Menu</b> key to enable <b>Background Hunt</b>, <b>Home Sta. Hunt</b>, or <b>Handover</b>.</li></ul>

Home Station Hunt	In a BS overlapping area, this feature allows the radio to switch back to the home station channel when its signal strength reaches the preset threshold. It is recommended that you set your frequently used channel as the home station channel.	<ul style="list-style-type: none"> <li>● Press the preprogrammed <b>Background Hunt</b>, <b>HomeStation Hunt</b>, or <b>Multi-site Handover</b> key.</li> </ul>
Multi-site Handover	The signal strength received from a BS may fluctuate due to position change, affecting the communication quality of the radio. On such occasions, this feature allows the radio to automatically register with the BS with stronger signal.	
Vote Now	This feature allows an idle radio to check the signal strength of the BS assigned in a broadcast call, and decide whether to register with the BS.	This feature is enabled by default.

## 8.5 Positioning

The Positioning feature allows you to collect the position information of the radio through satellites.

### NOTE

This feature applies only to radios with GPS, BDS, or GLONASS.

### 8.5.1 Enabling the Positioning Feature

- In conventional mode, go to **Menu > GPS > GPS On/Off**, **COMPASS On/Off**, or **GLONASS On/Off**, and then press the **OK/Menu** key to enable the positioning system.
- In trunking mode, this feature is enabled by your dealer.

### 8.5.2 Selecting the Positioning System

The radio supports positioning systems including GPS, BDS/GLONASS, and BDS/GLONASS+GPS. To select the positioning system, go to **Menu > GPS > Position Sys**.

### NOTE

This feature applies only to radios with BDS or GLONASS.

## 8.5.3 Viewing the Position

### 8.5.3.1 Viewing the Local Position

Go to the **Menu > GPS > Position**, and then press the **OK/Menu** key to view the position information of your radio (including longitude, latitude, time, date, and the number of satellites).

### 8.5.3.2 Viewing the Contact Position

- In conventional mode, go to **Menu > GPS > Query Location**, and then press the **OK/Menu** key to view the location information of a nearby private contact (including alias, direction, and distance).
- In trunking mode, go to **Menu > GPS > Query Neighbors**, and then press the **OK/Menu** key to view the location information of a nearby private or group contact (including alias, direction, and distance).

## 8.5.4 Sending a Position Message

- In conventional mode, you can send a position message to a contact. Do as follows:
  1. Go to **Menu > GPS > Position > GPS Msg**.
  2. Press the **OK/Menu** key to enter the contact list, and then select the contact.
  3. Press the **OK/Menu** key to send the message to the contact.
- In trunking mode, you can send a position message to the dispatch station. Do as follows:
  1. Go to **Menu > GPS > Msg with Position**.
  2. Press the **OK/Menu** key to edit the message.
  3. Press the **OK/Menu** key to send the message.

## 8.5.5 Call Location

During a call, if the transmitting radio is enabled with the Call Location feature, the receiving radio displays the location information of the transmitting radio when receiving valid positioning data.

### 8.5.5.1 Voice w/Location

The Voice w/Location feature allows the radio to report its location information when initiating a private call, a group call, or an emergency call.

Go to **Menu > GPS > Call Location > Voice w/Location**, and then press the **OK/Menu** key to enable the feature.

### 8.5.5.2 Display Call Location

If the transmitting radio is enabled with the Voice w/Location feature and the receiving radio is enabled with the Display Call Location feature, the receiving radio displays the location information of the transmitting radio during

a call.

1. Go to **Menu > GPS > Call Location > Display Call Location**, and then press the **OK/Menu** key to enable the feature.
2. Go to **Menu > GPS > Call Location > Display Type**, select **16 Azimuth & Dist., Accur Azimuth & Dist.,** or **Talker Location**, and then press the **OK/Menu** key.

### 8.5.5.3 GPS Report

The GPS Report feature allows the radio to report its location information to the control center or trunking system.

- In conventional mode, you can report the GPS data to the control center by pressing the preprogrammed **GPS Report** key. Alternatively, you can consult your dealer to configure the GPS trigger, allowing the radio to automatically report the GPS data upon power-on/off, or according to the preset time or distance interval.
- In trunking mode, with the GPS Active Report feature enabled by your dealer, the radio automatically reports the GPS data when reaching the preset time or distance. If the radio is enabled with the GPS Report in Voice feature, the radio actively reports GPS data during a call.

### 8.5.5.4 Quick GPS

Based on GPS standard time, the Quick GPS feature divides the GPS upload time into several equal-length time slices. These time slices are allocated to radios with different configurations for periodic upload and single upload. Each radio uses the same GPS upload time length to upload GPS data, improving upload efficiency and reliability.

If your dealer configures the feature to a digital channel, the channel only reports the quick GPS data.

## 8.6 BT

BT is a wireless technology that supports short-distance communications and data exchange between devices. You can connect the radio to a BT device through the built-in BT module.

---

#### CAUTION

- To derive optimal communication quality, it is recommended to use the BT devices approved by the Company.
- If BT earpieces of other companies are used, you must use them with the wireless ring PTT of the Company. Otherwise, the earpieces cannot transmit

---

To enable or disable the BT feature, do either of the following:

- Press the preprogrammed **BT** key
- Go to **Menu > BT**, and then press the **OK/Menu** key.

After this feature is enabled, the LED indicator flashes blue every three seconds.

---

 **NOTE**

The BT feature applies only to radios with the BT module.

---

## 8.6.1 Connecting a BT Device

1. Turn on the BT device and enter the pairing status. Refer to the accessory manual for details.
2. Search and connect to the BT device.
  - Go to **Menu > BT > Manual Search > Match PTT/Match Earphone**, enter the MAC address, and then press the **OK/Menu** key.
  - Go to **Menu > BT > Auto Search**, select the BT device from the detected device list, and then press the **OK/Menu** key.

After the radio is connected to the BT device, the LED indicator of the radio flashes blue every 1.5 seconds.

## 8.6.2 BT Audio Switch

With the BT device connected, you can press the preprogrammed **BT Audio Switch** key to switch the audio output device between BT earpiece and the radio.

## 8.6.3 Setting the BT

- To change the BT name, go to **Menu > BT > My Device > BT Devices Name**, enter the new name, and then press the **OK/Menu** key.
- To set visibility, go to **Menu > BT > My Device > Always Detected**, and then press the **OK/Menu** key to enable the feature.

Other BT devices can detect the radio.

## 8.7 One Touch Call/Menu

The One Touch Call/Menu feature allows you to initiate a preset service or switch to the function menu by pressing the preprogrammed **One Touch Call/Menu** key.

The following table shows the services that can be implemented by this feature and the corresponding operations.

Mode	Description	Operation
Conventional Mode	On an analog channel, you can initiate a call to a 2-tone contact.	<ul style="list-style-type: none"> <li>● Through Numeric Keypad               <ol style="list-style-type: none"> <li>1. Go to <b>Menu &gt; Settings &gt; Basic Settings &gt; Keypad Mode</b>, select <b>One Touch Call/Menu</b>, and then press the <b>OK/Menu</b> key.</li> <li>2. On the home screen, press the numeric key to initiate the service.</li> </ol> </li> <li>● Press the preprogrammed <b>One Touch Call/Menu</b> key to initiate the service.</li> </ul>
	On a digital channel, you can do one of the following: <ul style="list-style-type: none"> <li>● Initiate a group, private, or all call.</li> <li>● Send a quick text message or position message to a private or group contact.</li> <li>● Initiate an alert call, radio check, remote monitor, revive, or kill service.</li> <li>● Switch to a function menu or realize a function.</li> </ul>	
Trunking Mode	<ul style="list-style-type: none"> <li>● Initiate a group, private, all, broadcast, or emergency call.</li> <li>● Send a quick text, status, or user-defined message.</li> <li>● Switch to a function menu or realize a function.</li> </ul>	

 **NOTE**

To initiate a call on a digital channel, you must press and hold the **PTT** key after pressing the **One Touch Call/Menu** key.

## 8.8 Quick Dial

On the home screen, the Quick Dial feature allows you to enable or disable a feature or switch to a function menu by manual dialing. This feature is available only when the keypad input is enabled.

If You...	In Different Modes	Then You Can...
Press a numeric key (0–9) and then the <b>OK/Menu</b> key on the home screen	Conventional mode	<ul style="list-style-type: none"> <li>● Adjust the power level.</li> <li>● Set the backlight.</li> <li>● Switch the operation mode.</li> <li>● Check the radio information.</li> <li>● Enable/disable the alert tone.</li> </ul>

	Trunking mode	<ul style="list-style-type: none"> <li>● Adjust the power level.</li> <li>● Set the backlight.</li> <li>● Switch the operation mode.</li> <li>● Check the radio information.</li> <li>● Enable/disable the alert tone.</li> <li>● View control channels.</li> </ul>
Enter several numbers, and then press the <b>OK/Menu</b> key	Conventional mode	/
	Trunking mode	Switch the BS, control channel, system code, or current talk group.  <b>NOTE</b> For details, contact your dealer.

---

 **NOTE**

In conventional mode, with the keypad input and Quick Dial feature enabled, you can do either of the following:

- On the home screen, enter "0", and the quick dial text box appears.
- Press  to switch between the contact text box and the quick dial text box.

On an analog channel, the radio displays only the quick dial text box.

---

## 8.9 Roam

### 8.9.1 Conventional Mode

The Roam feature allows you to select base stations according to signal strength. This ensures seamless communication across sites or networks.

With the Roam feature enabled by your dealer, you can do either of the following:

- To enable the Roam Feature, do either of the following:
  - Press the preprogrammed **Roam** key.

- Go to **Menu > Roam > On/Off**, and then press the **OK/Menu** key.
- To set the roam list, go to **Menu > Roam > Roam List**, select a roam list, and then add or delete channels in the list.

A roam list contains a group of channels under monitoring. Each list contains up to 32 channels.

## 8.9.2 Trunking Mode

The Roam feature allows the radio to be registered with a non-home BS or network when it is on move. When the radio detects signal, it initiates the registration.

This feature is enabled by your dealer.

## 8.10 Clarity Transmission

The Clarity Transmission feature allows data transferred from one external device to another using the radio. The radio serves as the transparent transmission channel for data exchange between external devices without any additional adjustment. This feature is enabled by your dealer.

### 8.10.1 Conventional Mode

When the radio receives the data through the serial port, it transfers the data to a preset contact excluding an all call contact.

### 8.10.2 Trunking Mode

When the radio receives the data through the serial port, it transfers the data to a preset private or group contact by using short data or packet data.

To enable or disable the feature, press the preprogrammed **Clarity Transmission Mode** key.

In the Clarity Transmission mode, the radio is capable of only transmitting or receiving data.

## 8.11 DGNA

The Dynamic Group Number Assignment (DGNA) feature allows you to initiate a call to or receive a call from a dynamic group temporarily created by a dispatch station. The created dynamic group is saved in a dynamic group menu on the radio.

The radio displays "DGNA Successful" when the dynamic group is added and "DGNA Deleted" when the dynamic group is deleted. You cannot use the dynamic group after it is deleted.

For operations of initiating, receiving, or ending a DGNA call, see [6.1 Group Call](#).



## 8.12 Ignition Sense

The Ignition Sense feature controls the radio on or off and the **PTT** key enabled or disabled by starting or stopping your vehicle.

Four types of ignition sense are listed in the following table. The default type is **Disable Ignition Off**, and other types are enabled by your dealer.

Type	Description	Operation
Ignition or Switch	Allows you to turn the radio on or off by the engine or the <b>On-Off</b> key.	<ul style="list-style-type: none"> <li>● To turn the radio on, start the engine or long press the <b>On-Off</b> key.</li> <li>● To turn the radio off, stop the engine or press the <b>On-Off</b> key.</li> </ul>
Ignition Only	Allows you to turn the radio on or off by the engine.	To turn the radio on or off, start or stop the engine.
PTT Disable	Allows you to enable or disable the <b>PTT</b> key by the engine.	To enable or disable the <b>PTT</b> key, start or stop the engine.
Disable Ignition Off	Allows you to turn the radio on by the engine or the <b>On-Off</b> key, and allows you to turn the radio off only by the <b>On-Off</b> key.	<ul style="list-style-type: none"> <li>● To turn the radio on, start the engine or long press the <b>On-Off</b> key.</li> <li>● To turn the radio off, press the <b>On-Off</b> key.</li> </ul>

## 8.13 Public Address

The Public Address feature allows you to address public through the external speaker (connected to the accessory connector on the rear panel).

- To enable the feature, press the preprogrammed **Public Address** key.
- To disable the feature, press the preprogrammed **Public Address** key again.

## 8.14 Priority Interrupt

The Priority Interrupt feature allows you to interrupt the ongoing activities (such as a call, a call hang status or remote monitor) on the current channel to release it: therefore, you can initiate a new call or a new data service on that channel. This feature includes manual priority interrupt and auto priority interrupt.

## 8.14.1 Manual Priority Interrupt

Press the preprogrammed **Priority Interrupt** key to interrupt the ongoing activities.

## 8.14.2 Auto Priority Interrupt





Auto Priority Interrupt includes Emergency Priority Interrupt, Call Back Priority Interrupt, Message Priority Interrupt, Radio Disable Priority Interrupt, and All Call Priority Interrupt.

With this feature enabled by your dealer, you can interrupt an ongoing call by initiating an emergency call, all call, or sending a short message or the Radio Disable command.

## 8.15 Emergency

The Emergency feature allows you to seek help from your companion or the control center in case of emergency. You can initiate an emergency call with the highest priority even when your radio is transmitting or receiving.

In emergency mode, the radio transmits at high power level by default. According to the emergency type preset by your dealer, the radio gives different indications. The available emergency types are listed in the following table.

Emergency Type	Description
Siren Only	The radio emits siren and displays  and  , but does not transmit any emergency signal to the control center.
Regular	The radio gives visible or audible indications.
Silent	The radio gives no visible and audible indication.
Silent w/Voice	The radio gives audible indication only upon receiving a call. Otherwise, the radio gives no audible or visible indication.
Alarm w/Siren	The radio transmits the emergency signal to the control center, and then emits siren and displays  and  .

In addition, you can request your dealer to set one of the following emergency modes:

Emergency Mode	Description	Note
Call Only	It allows you to initiate an emergency call.	If the emergency type is Siren Only or Alarm w/Siren, you do not need to set the emergency mode.
Alarm w/Call	It allows you to send an emergency code and initiate an emergency call.	

Emergency Mode	Description	Note
Alarm	It allows you to send an emergency code.	

## 8.15.1 Initiating an Emergency Call

Press the preprogrammed **Emergency On** key to initiate an emergency call to the preset contact.

If the Alarm w/Call To Follow feature is enabled by your dealer, you can speak into the microphone without pressing or holding the **PTT** key. If the preset voice cycles expire, you can press and hold the **PTT** key to initiate the emergency call again.

## 8.15.2 Receiving an Emergency Call

You can answer an emergency call without any operation.

## 8.15.3 Ending an Emergency Call

The calling party can end an emergency call by pressing the preprogrammed **Emergency Off** key or turning off the radio.

The called party can exit an emergency call by switching the channel or turning off the radio.

## 8.16 Horn & Lights

The Horn & Lights feature allows the radio to alarm through the external alarm devices (speaker or light) in the following scenario:

The radio makes no operation within the preset time after receiving an emergency alert, a call alert or a private call.

You can request your dealer to configure one of the following types of Horn & Lights for your radio.

Alarm Type	Description
Alarm Re-Arm	The Horn & Lights feature is enabled or disabled based on the setting upon the last power-off.
Non-Permanent Manual Re-Arm	The Horn & Lights feature must be enabled every time upon power-on.
Permanent External Alarm	The Horn & Lights feature is enabled whenever the radio is powered on.

To enable the feature, do either of the following:

- Go to **Menu > Accessories > Horn & Lights > On**, and then press the **OK/Menu** key.

- Press the preprogrammed **Horn & Lights** key.

## 8.17 Emergency Erase Data

The Emergency Erase Data feature allows the radio to erase encrypted data in case of emergency, so as to prevent unauthorized access. When erasing the data, the radio stops voice and data services and returns to the home screen.

If this feature is enabled by your dealer, the encrypted data can be erased in the following cases:

- Press the **P1** key and then the **PTT** key (within 1.5s) for two times, and then press the **P1** key again.
- When the radio is killed, the data in the radio will be erased automatically.

## 8.18 Stun, Revive, and Kill

### 8.18.1 Conventional Mode

The Kill feature allows you to send a command to a private contact to disable the radio. The killed radio can be monitored remotely, but is deprived of other features. The radio can only be revived by reprogramming through the programming software or the Radio Enable command.

You can enable the radio of a private contact remotely and allow it to be used normally.

### 8.18.2 Trunking Mode

When the radio is stunned by the dispatch station or trunking system, the radio displays "Radio Stunned". In this case, the radio cannot initiate or receive any network service (including calls and short messages), but retains features such as registration, revive, kill, and authentication. A stunned radio can restore to normal use when receiving the revive command from the dispatch station or trunking system. Then the radio displays "Revive Successful".

When the radio is killed by the dispatch station or trunking system, the radio displays "Radio Killed". In this case, the radio is incapable of any function except power-on/off. To restore normal use, send the radio back to the Company.

The Stun, Revive, and Kill features are enabled by your dealer by default and triggered by the dispatch station or trunking system.

## 9. Troubleshooting

Phenomena	Analysis	Solution
The radio cannot be turned on.	The power cord may be unconnected.	Connect the power cord properly .
The radio cannot be registered.	The radio cannot detect signal from the BS.	Make sure the radio is within the coverage of the BS.
	The radio may not be authorized.	Contact the BS manager to check whether the radio is authorized in the network management system.
The radio is registered repeatedly.	The signal may be intermittent.	Make sure that the radio is within the coverage of the BS.
The radio cannot establish a call.	The signal may be weak.	Make sure that the radio is within the coverage of the BS.
No voice is heard after a call is established.	The radio ID may be repeated.	Contact the BS manager to check whether the radio ID is repeated in the network management system.
The called party disconnects repeatedly during communication.	The signal may be intermittent or weak.	Make sure that the radio is within the coverage of the BS.
The voice is unclear.	The signal may be weak.	Make sure that call participants are within the communication range.
During receiving, the voice is weak, discontinuous, or totally inactive.	The battery voltage may be low.	Recharge or replace the battery.
	The volume may be low.	Increase the volume, or contact your dealer to disable the Mic AGC feature.
	The antenna may be loosened or installed improperly.	Turn the radio off, and then reattach the antenna.
	The speaker may be blocked or damaged.	Clean the surface of the speaker.

Phenomena	Analysis	Solution
Communications with group members are unavailable.	The frequency or signaling type may be inconsistent with that of other members.	Set your TX/RX frequency and signaling to the same as that of other members.
	The channel type (digital or analog) may be set inconsistently.	Make sure that all members are on the same digital or analog channel.
	You may be too far away from the group members.	Move towards other members.
	The signal may be weak.	Make sure that call participants are within the communication range.
There are unknown voices or noises on the channel.	You may be interrupted by radios using the same frequency.	Change the frequency, or adjust the squelch level.
	The radio may be set with no signaling.	Set signaling for all member radios to avoid interference at the same frequency.
There is too much noise and hiss.	The signal may be weak.	Make sure that call participants are within the communication range.
	The radio may be in an unfavorable position. For example, the signal may be blocked by tall buildings or frustrated in the underground areas.	Move to an open and flat area, and then restart the radio.
	The radio may suffer from external disturbance (such as electromagnetic interference).	Stay away from the equipment that may cause interference.
The keys are unavailable.	The keypad may not work temporarily.	Restart the radio.
The LCD does not display any information.	The LCD may not work temporarily.	Restart the radio.
The GPS cannot locate your position.	The radio may be at an unfavorable position, so no GPS signal is received.	Move to an open and flat area, and try again.

If the above solutions cannot solve your problems, or you may have some other queries, please contact us or your local dealer for more technical support.

# 10. Care and Cleaning

To guarantee optimum performance as well as a long service life of the product, please follow the tips below.

## 10.1 Product Care

- Do not pierce or scrape the product.
- Keep the product away from substances that can corrode the circuitry.
- Close the accessory connector cover when no accessory is in use.

## 10.2 Product Cleaning

---

### CAUTION

Turn off the product and remove the battery before cleaning.

---

- Clean up the dust and fine particles on the product surface and charging piece with a clean and dry lint-free cloth or a brush regularly.
- Use neutral cleanser and non-woven fabric to clean the keys, knobs, and front case after long-time use. Do not use chemical preparations such as stain removers, alcohol, sprays or oil preparations, so as to avoid surface case damage.
- Make sure the product is completely dry before use.

# 11. Optional Accessories

---

 CAUTION

Use the accessories approved by the Company only. Otherwise, we will not be liable for any loss or damage arising out of the use of unauthorized accessories.

---

Contact your local dealer for the optional accessories used with the product.



## 12. Abbreviations

Abbreviation	Full Name
A	
AGC	Automatic Gain Control
D	
DTMF	Dual-tone Multi-frequency
F	
FOACSU	Full Off Air Call Set-Up
G	
GPS	Global Positioning System
L	
LCD	Liquid-Crystal Display
LED	Light-Emitting Diode
O	
OACSU	Off Air Call Set-Up
P	
PABX	Private Automatic Branch eXchange
PSTN	Public Switched Telephone Network
PTT	Push-To-Talk
R	
RRS	Radio Registration Services
T	
TF	TransFlash
TK	Top Key
X	
XPT	Extended Pseudo Trunk



is the trademark or registered trademark of Hytera Communications Corporation Limited.

© 2020 Hytera Communications Corporation Limited. All Rights Reserved.

Address: Hytera Tower, Hi-Tech Industrial Park North, 9108# Beihuan Road, Nanshan District, Shenzhen, People's Republic of China Postcode: 518057

[http:// www.hytera.com](http://www.hytera.com)